

# FIRESTORM MK06

**7.1 RGB  
GAMING HEADSET**

INSTRUCTION MANUAL  
AFSH0520



**ADX** 

# Contents

---

<b>Safety Warnings</b> .....	<b>3</b>
<b>Unpacking</b> .....	<b>4</b>
<b>Product Overview</b> .....	<b>5</b>
<b>System Requirements</b> .....	<b>6</b>
<b>Software Installation</b> .....	<b>6</b>
<b>Connections</b> .....	<b>7</b>
<b>User Interface</b> .....	<b>8</b>
<b>User Interface</b> .....	<b>9</b>
<b>Speaker Setting</b> .....	<b>9</b>
<b>Mic Setting</b> .....	<b>14</b>
<b>Hints and Tips</b> .....	<b>17</b>
<b>Specifications</b> .....	<b>17</b>

# Safety Warnings

---

- For traffic safety, do not use earphones while driving or cycling.
- Listening to loud sounds for prolonged periods of time may permanently damage your hearing.
-  Before putting on earphones, turn the volume down then put the earphones on and slowly increase the volume until you reach a comfortable listening level.

**Thank you** for purchasing your new product.

We recommend that you spend some time reading this instruction manual in order that you fully understand all the operational features it offers. You will also find some hints and tips to help you resolve any issues.

Read all the safety instructions carefully before use and keep this instruction manual for future reference.

## Unpacking

---





Remove all items from the packaging. Retain the packaging. If you dispose of it please do so according to local regulations.

The following items are included:

- Gaming Headset
- Microphone
- 3.5mm audio cable x 1
- Type C audio cable x 1
- Instruction Manual (downloadable)
- Software (downloadable)

# Product Overview

---

1.  **Microphone**
2.  **USB audio socket**
3.  **3.5mm audio socket**
4.  /  **Mute button**
5. **Volume control**

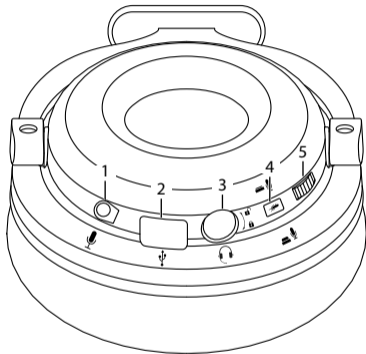

## System Requirements

---

**Operating Systems:** Microsoft® Windows® 8 / 10

**Hardware:** 1 available USB port

## Software Installation

---

1. Plug the unit into the USB port of your computer.
2. Download the latest gaming software from **<http://ADXgaming.com/downloads>**
3. Run the software installer.
4. Follow the installation instruction to complete the installation.
5. Choose **ADX AFSH0520.exe** from the desktop to start the software.



- Software only works when the headset is connected with the type C audio cable.
- The software is not available for MAC OS.

# Connections

---

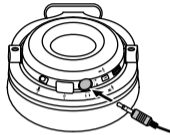
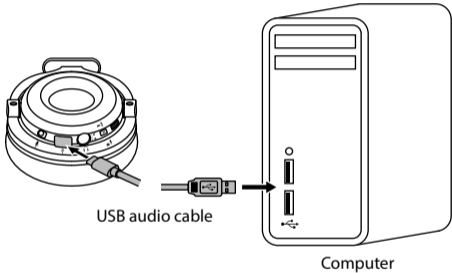

Type C port will disable while using the 3.5mm audio cable.

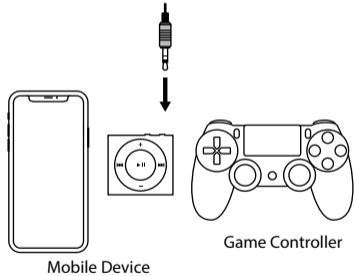

# User Interface

---

Choose **ADX AFSH0520.exe** from the desktop to start the software.

1. Software **Information**.
2. **Setting** options.
3. **Minimise** the software.
4. **Exit** the software.
5. Enabled feature will be highlighted.
6. Switch between **Status** and **Profile** panel.
7. Adjust the **volume**.
8. **Mute** or restore the sound.

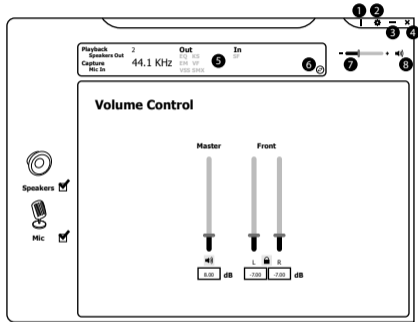



# Menu

Right click the icon from the system tray will pop up a menu that links to Windows default software.

1. **Open** the headset software.
2. Open the default Windows **Volume Control**.
3. Open the default **Windows Media Player**.
4. Open the default Windows **Sound Recorder**.
5. Open the default Windows **Multimedia Properties**.
6. Open the headset software **Settings**.
7. **Exit** the headset software.



10:00  
20/9/2020

# Speaker Setting

Right click on  to show a speaker menu.

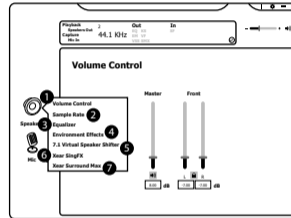

1. Volume Control
2. Sample Rate
3. Equalizer
4. Environment Effects
5. Virtual Speaker Shifter
6. Xear SingFX
7. Xear Surround Max

## 1. Volume Control

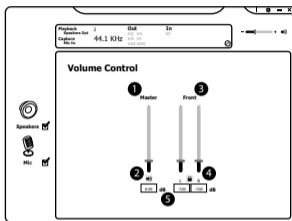

1. Adjust the volume.
2. Mute or restore the sound.
3. Adjust the left or right front speaker volume individually.
4. Lock the left and right speaker to adjust at once.
5. Range of volume in dB is between -37.00 and 0.00.

## 2. Sample Rate

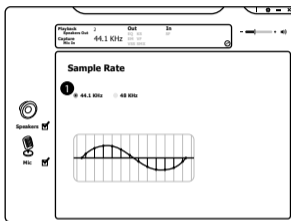

1. Choose a different audio sample rate of your choice.

### 3. Equalizer

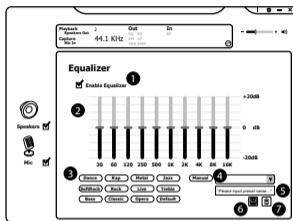

1. Enable/Disable Equalizer
2. Customise the EQ setting.
3. Choose a sound effect mode of your choice.
4. Select saved EQ profile.
5. Input preset name.
6. Save a current EQ setting.
7. Delete a selected setting.

### 4. Environment Effects

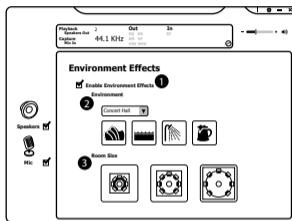

1. Enable/Disable Environment Effects.
2. Adjust environment effect.
3. Adjust room size effect.

## 5. Virtual Speaker Shifter

Allows for personal calibration to fit for your ears, enabling you to configure to your perfect individual setting.

1. Enable/Disable **Virtual Speaker Shifter**.
2. Rotate Clockwise.
3. Rotate Counter Clockwise.
4. Manual Rotate.
5. Manual Shifter.
6. Reset to default hearing.
7. Adjust the speaker hearing position.
8. Adjust dB levelling.

<b>L:</b> Left speaker	<b>Lb:</b> Back Left
<b>R:</b> Right speaker	<b>Rb:</b> Back Right
<b>Ls:</b> Side Left	<b>c:</b> Centre speaker
<b>Rs:</b> Side Right	<b>w:</b> Woofer

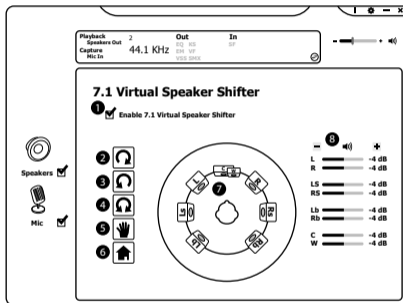

## 6. Xear SingFX

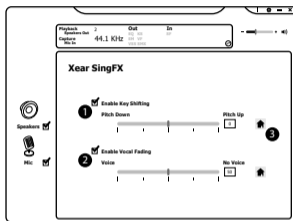

1. Enable/Disable **Enable Key Shifting** feature and adjust the Pitch level.
2. Enable/Disable **Enable Vocal Fading** feature and adjust the voice fading level.
3. Press  to return to default setting.

## 7. Xear Surround Max

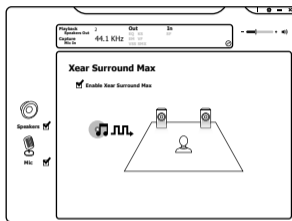

When **Xear Surround Max** is enabled, contents being played by the front left and right virtual speakers will be cloned to all side and back speakers.

**Xear Surround Max** can be enabled when **Speaker Shift** or **Real Multi-Channel Output** setting is turned on.

# Mic Setting

Right click on  to show microphone menu.

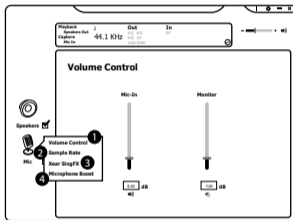

1. Volume Control
2. Sample Rate
3. Xear SingFX
4. Microphone Boost

## 1. Volume Control

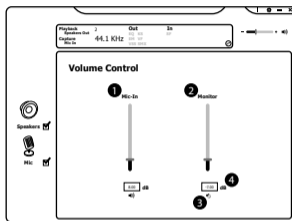

1. Adjust the microphone volume.
2. Listen to your own voice when using microphone to speak.
3. Mute or restore the microphone.
4. Range of volume in dB between -37.00 and 0.00.

## 2. Sample Rate

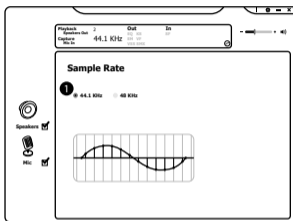

1. Choose a different audio sample rate of your choice.

## 3. Xear SingFX

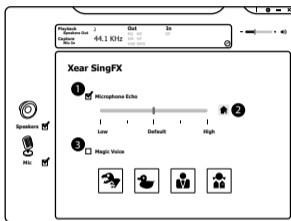

1. Enable/Disable **Microphone Echo** feature and adjust the echo level.
2. Press 🏠 to return to default setting.
3. Choose a **Magic Voice** of your choice.

## 4. Microphone Boost

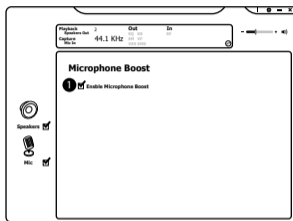

1. Enable **Microphone Boost** to improve the quality of your audio recordings.



## Hints and Tips

---

- Make sure the USB plug is fully plugged into a USB port and the computer is on or try to use a different USB port.
- If the software is not working properly, uninstall it and then reboot the computer. Re-install the software.
- If the unit is not working properly, re-insert the USB plug into the USB port.

## Specifications

---

### Headphones

<b>Frequency Response</b>	20Hz – 20kHz
<b>Sensitivity @ 1kHz</b>	100 ± 3dB
<b>Impedance</b>	32 ± 15%Ω
<b>Net Weight</b>	300 g

### Microphone

<b>Frequency Response</b>	20Hz – 20kHz
<b>Sensitivity @ 1kHz</b>	-42 ± 3dB
<b>Directivity</b>	Omnidirectional
<b>Impedance</b>	≤2.2k Ω

Features and specifications are subject to change without prior notice.



The symbol on the product or its packaging indicates that this product must not be disposed of with your other household waste. Instead, it is your responsibility to dispose of your waste equipment by handing it over to a designated collection point for the recycling of waste electrical and electronic equipment. The separate collection and recycling of your waste equipment at the time of disposal will help conserve natural resources and ensure that it is recycled in a manner that protects human health and the environment. For more information about where you can drop off your waste for recycling, please contact your local authority, or where you purchased your product.

Nintendo Switch is a registered trademark of Nintendo Co., Ltd.

Xbox is a registered trademark of the Microsoft Corporation.

PS4 is a registered trademark of Sony Interactive Entertainment Inc.

All trademarks are the property of their respective owners and all rights are acknowledged.

DSG Retail Ltd. (co. no. 504877)  
1 Portal Way, London, W3 6RS, UK

**EU Representative**

DSG Retail Ireland Ltd (259460)  
3rd Floor Office Suite  
Omni Park SC, Santry, Dublin 9, Republic of Ireland

IB-AFSH0520-200914V1